

Safety and Quality in Combined Transport (CT)

This document provides the essential information needed to ensure safe consignments in combined transport



Changes in the document “Safety and quality in combined transport (CT)”			
Supplement		Supplement	
No.	dd.	No.	dd.
1	01.01.2009		
2	01.07.2011		
3	01.02.2013		
4	01.04.2013		
5	01.12.2013		
6	01.03.2015		
7	01.01.2016		
8	01.01.2017		
9	01.07.2018		
10	01.09.2019		
11	11.08.2022		

This document and its contents have been written by Fabio Contrafatto and Olimpio Rivera.

Any comments and requests regarding this document can be addressed to:

Hupac Intermodal SA – Chiasso
Fabio Contrafatto
Tel.: +41 58 8558070
E-mail: fcontrafatto@hupac.com

Hupac Intermodal SA - Chiasso
Olimpio Rivera
Tel.: +41 58 8558335
E-mail: orivera@hupac.com

Index

1	Foreword	5
2	Standards of conduct for terminal users (drivers / others)	5
3	Rules governing the condition of ITUs	6
4	Identification of ITUs	7
4.1	Introduction	7
4.2	Containers	7
4.3	Swap bodies / Semi-trailers	8
4.4	Loss of the codification plate	8
4.5	Modifications to ITUs	8
4.6	ILU-Code	9
5	Advance notification of an ITU consignment	10
6	Technical consultation concerning ITUs and options for loading on railway routes	10
6.1	Services / Contacts for information	10
7	Combined transport (block trains without manoeuvre)	11
7.1	Stresses during transport	11
7.2	Conditions of the ITUs used for transport	11
7.3	Loading system	11
7.4	Load securing	11
7.5	Securing only by means of canvas covers, roof arches and metal structures is not sufficient	11
7.6	Loading examples	12
7.6.1	Sacks	12
7.6.2	Boxes	12
7.6.3	Paper rolls transversally positioned	12
7.6.4	Standing paper rolls and barrels	12
7.6.5	Coils transversally positioned	12
7.6.6	Panels, steel sheeting	12
7.6.7	Pipes and steel profiles in bundles	12
7.6.8	Scrap, waste paper (loose or bundled), powdery materials, sand and gravel	12
7.7	Canvas covers for covering the load	13
7.8	Special provisions for the loading of swap bodies / containers onto pocket wagons	13
8	Condition of the ITU	14
8.1	Regulations for the ITU	14
8.2	Supplementary instructions for the loading of ITUs	14
8.2.1	Concentrated loads: coils, marble/granite blocks and other heavy goods	14
8.2.1.1.	Coils	14
8.2.1.2.	Marble/granite blocks	15
8.2.2	Fastening	15
8.2.3	Securing of standing paper rolls	16
8.2.4	Displacement of the load	17
8.2.4.1.	Wire rod rolls	17
8.2.5	Incorrectly distributed load	18
8.2.6	Hermetic sealing of ITUs / Presence of goods outside ITUs	19
8.2.7	Flexitank	20
8.2.8	Containers and stacked swap bodies	22
8.3	Regulations for all the ITUs fitted with tarpaulin	23
8.4	Regulations for tank containers	28
8.5	Provisions for Open Top containers	29
8.6	Hazardous Goods Transport	29
8.6.1	Labelling regulations for vehicles containing hazardous goods	30
8.6.2	Transport of Class 1 materials	31
8.6.3	Transport of Class 7 materials	31
8.6.4	Description N.O.S. (Not Otherwise Specified)	31
8.6.5	Transport of lithium-metal batteries	31
8.6.6	Control of loading units and drivers	37
8.6.7	Temporary storage of ITUs with dangerous goods	37
8.7	Transport of waste	37
8.8	Regulations for all the ITUs with doors, headwalls and sideboards	38

8.9	Regulations for ITUs with openable roofs.....	38
8.10	Specific regulations for swap bodies / containers.....	39
8.11	Specific regulations for swap bodies	39
8.12	Specific regulations for containers.....	39
8.13	Regulations for empty stacked flats.....	40
8.14	Regulations for flats with frontal doors	40
8.15	Specific regulations for semi-trailers.....	41
8.16	Regulations for swap bodies and semi-trailers	43

1 Foreword

Hupac keeps on examining the risks of its business activities, paying particular attention to the health and safety of people and consignments, the quality of services and the respect for the environment. It is of fundamental importance that all stages regarding the delivery of the loading units to terminals, their handling, loading and unloading in terminals as well as the train preparation and delivery to railway and transport companies are carried out in a safe and environmentally friendly way.

The greatest risks derive from accidents, which might result in injuries and damage to intermodal transport units (ITUs), to the goods they contain, to terminal and railway infrastructures, to third parties' property and to the environment. They can also derive from derailments, fires and prolonged service interruptions along the lines.

Safety is a priority for Hupac that does its best to create a safe and reliable transport system and is committed to improving safety in all areas it manages.

Hupac has decided to prepare this document, in order to provide its clients with the essential information for ensuring safety of consignments in combined transport.

We kindly ask our customers to respect the regulations on loading and securing loads, as well as all the other measures detailed in this document, with the aim of guaranteeing transport safety without endangering terminal and/or railway activities, assets and people.

2 Standards of conduct for terminal users (drivers / others)

Summary of hazards:

- presence of lifting equipment in movement and in operation;
- presence of railway vehicles in motion;
- presence of operating staff, on foot or bicycle;
- presence of loading units designed for the transport of hazardous goods.

Conduct standards:

- obey the instructions of the operating staff;
- respect the indicated speed limits;
- use the requested personal protective equipment;
- pay attention to suspended loads;
- pay attention to any obstacle or protrusion of containers;
- pay attention to moving railway vehicles;
- pay attention to instruction signs;
- switch off the engine when the vehicle is stationary.

Prohibited:

- unauthorised entry to terminals;
- smoking within the terminal area;
- use of naked flames or any equipment which may create a source of heat;
- stopping alongside any crane with suspended loads or directly beneath them;
- crossing of lines with approaching or moving railway vehicles;
- climbing aboard railway wagons without authorisation;
- film or photograph without authorisation.

Conduct in case of emergency:

- alert the operating staff of the alarm;
- distance yourself immediately from the source of danger, following the instructions given by the operating staff;
- don't take any personal initiative;
- reach the indicated meeting point;
- follow the escape routes and reach the indicated meeting point.

3 Rules governing the condition of ITUs

Firstly, it is necessary to point out that according to Art. 5.1 of the General Conditions of the International Union of Combined Rail and Road Transport Companies (hereinafter called "UIRR General Conditions"), by signing the contractual form, the customer engages himself in the way that:

1. the data supplied by him, concerning ITUs and goods, with particular regard to the weight and nature of these ones, are exact and complete, independently of the fact that it is the customer himself or the UIRR company entering or getting entered these data in the contractual form;
2. all the documents accompanying the ITU and which are prescribed by the relevant authorities for the different inspections are duly and correctly filled in;
3. any particular dispositions in force in the countries concerned with the transport of the ITU are likewise respected.

Concerning the condition of ITUs, the goods therein contained and the customer's responsibility, please note that Art. 5.2 of the UIRR General Conditions establishes that:

"In using an ITU, the client guarantees it is suitable for combined transport and that both the ITU and the goods it contains meet the safety criteria required for that type of transport."

With a "suitable" ITU we mean that it has been technically approved for combined transport, that it has a codification plate or, in the case of ISO containers, the "Safety Approval Plate" in accordance with the "Container Safety Convention", and that the condition of the ITU has not substantially changed since its approval for combined transport.

With "safety" we mean that the ITU and the goods it contains allow a thoroughly safe transport and above all that the packaging of the goods, their stowage and fastening within the ITU are suitable for the specific characteristics of combined transport. This particularly in the case of transport of liquid substances or goods which require a constant temperature.

According to Art. 5.3 of the UIRR General Conditions, the customer is responsible for all damage caused as the result of failing to observe the specified regulations, as in Art. 5.1, 5.2 and 6.3, even if no fault is attributable to him.

With regard to the hazardous goods, we remember that, according to Art. 6.2 of the UIRR General Conditions, an ITU containing authorised hazardous goods shall be in compliance with the legislative and regulatory provisions for its transport by rail and road both on a national and international level.

Art. 6.3 of the UIRR General Conditions specifies that, for the delivery of such an ITU, the customer engages himself, further to what specified in Art. 5, to:

- respect the dispositions laid down in Art. 6.2;
- write on the contractual form the exact denomination of goods, according to the specific rules in force for hazardous goods;
- transmit the suitable safety data sheets and the other necessary documents;
- communicate the precautions which shall be taken, that are prescribed by the relevant authorities or that are anyway necessary.

It is therefore up to the client to deliver Hupac ITUs in a perfect condition, in order to allow an absolutely safe transport.

The client shall ensure complete maintenance and care as well as an impeccable use of the vehicles which are utilised in combined transport. He shall guarantee that the greatest care is used in the phases of loading and securing goods.

The fact that vehicles and/or defective loads can cause serious events in the transport phase as well as damage and/or injuries, touches on not only civil but also criminal liability issues.

We also emphasise that suitable loading and securing of goods in the ITU falls into the realm of the customer's due care and diligence.

Due to the responsibility which is up to the customer with regard to the above, Hupac invites its customers to take out the adequate insurance policies.

4 Identification of ITUs

4.1 Introduction

ITUs have to bear the markings defined in points 4.2 or 4.3, which confirm the adherence of the railway transport to the UIC/IRS international regulations.

The markings on the containers are applied directly by manufacturers, while the codification plates on the swap bodies and semi-trailers shall be requested to the relevant authorities (intermodal transport companies, railway undertakings or national agencies) by filling in and signing the corresponding forms.

N.B.: ITUs without the correct markings will be rejected during the acceptance phase at the terminal.

4.2 Containers

Example of inscription, 2 pieces (one per side)

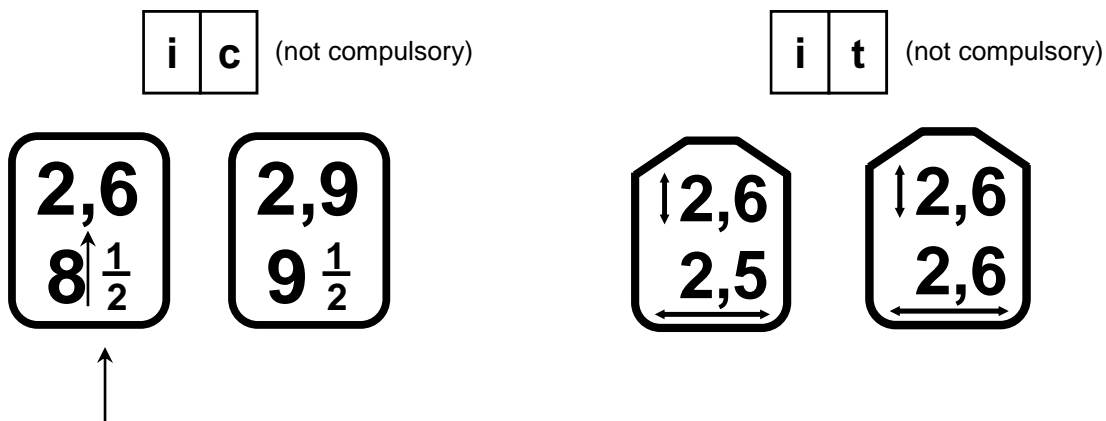

The height inscription of ISO-containers (ic) which have a height up to 2,591 mm, rounded to 2,600 mm, is optional.

However, it is recommended to apply it, in order to avoid any acceptance problems in some terminals.

CSC Plate (only the containers with upper corner pieces shall have a valid CSC plate for the coupling with the “spreader”).

CSC SAFETY APPROVAL			
*1*RI*05 - 932 - 9870*			
DATE MANUFACTURED	:	11-2006	
MANUFACTURER'S No.	:	C-0 445 / 2006	
MAXIMUM GROSS WEIGHT	:	23000 kg	50710 lb
ALLOW. STACK. WT. 1,8 G.	:	23000 kg	50710 lb
RACKING TEST LOAD VALUE	:	15290 kg	33710 lb
SIDE WALL STRENGTH 0.6 P	:	8020 kg	17680 lb
END WALL STRENGTH 0.4 P	:	8020 kg	17680 lb
DATE OF EXAMINATIONS	:	11-2011	<input type="text"/> <input type="text"/>

OR

CSC SAFETY APPROVAL			
F / BV / 7143 / 00			
DATE MANUFACTURED	:	01-2000	
IDENTIFICATION No.	:	TRIU	
MAXIMUM GROSS WEIGHT	:	34000 kg	74960 lb
ALLOW. STACK. WT. 1,8 G.	:	34000 kg	74960 lb
RACKING TEST LOAD VALUE	:	15260 kg	33600 lb
			ACEP USA 1984 0009

4.3 Swap bodies / Semi-trailers

Examples of codification plate, 2 pieces (one per side)

Swap bodies

S 29	C 28		850806 114955	30
→ 2550 ←		40 • 046 • 0901-4		

C44	45
S45	2500
	XL
040 • S10004 • 000000000000132391	

040 • S10003 • 000000000000100321	C29
	S29
	30
	2550
	XL

Semi-trailers

S 400	P 400	
40 • 351 • 0199		170 811 3139074

S386	P386	98 cm	a	b	c	d	e	f
			g	h	i			
40 • 551 • 0296		403 610		WKESD000 000484953				

P 386	abc3	
98	defg	
XL	hi	
040 • KR0054 • WKESD0000000582188		

040 • CC0073 • ZNF170BDFSF000747	P404
	98
	XL
	def
	ghi

4.4 Loss of the codification plate

The client shall inform Hupac in the event of loss of one or both codification plates of the ITU, by indicating the required technical data. Hupac will order the codification plate/s if this/these was/were issued by SBB/Hupac. In the other cases, Hupac will inform the authority which coded the ITU, so that the missing plates may be ordered as soon as possible.

The costs for the replacement of the codification plates shall be borne by the customer.

4.5 Modifications to ITUs

Any changes regarding the external profile, the solidity conditions or any other structural change may be applied to the coded ITU only after having obtained the approval by Hupac or the licensing authority.

The modifications shall be certified by the relevant bodies (e.g. RINA, TUV, etc.).

To obtain new plates (in the case of changes to the external profiles), the customer shall send a new application to Hupac or the homologating body.

In the case that the customer makes structural changes to an ITU without following the above-said procedure, he will be liable for any damage arising from the non-homologated amendments.

4.6 ILU-Code

A new system regarding the coding and identification of the loading unit's owner in combined transport came into force on July 1st, 2011. This new unified system, the ILU-Code (Intermodal Loading Unit Code), was introduced for the labelling of semi-trailers and swap bodies in accordance with the regulations EN 13044.

Thanks to the ILU-Code the advantages of the BIC-Code that was used with ISO-containers all over the world many years long, are extended also to semi-trailers and swap bodies. Every owner of intermodal loading units gets an owner's code (consisting of four letters), adds a six-digit numerical sequence according to his own criteria, completes it with a self-control figure that is automatically generated and applies this code to his own loading units.

Advantages of the ILU-Code:

- Thanks to the simple and univocal identification of the loading unit's owner, it is possible to automate and speed up the terminal and tracking & tracing procedures, the customs clearance, as well as to obtain high-quality data from booking to billing.
- In case of change of the owner, the technical codification remains valid because the identification of the ownership is separated from the yellow codification plate.
- Compatibility with the management systems of the container fleet with BIC-code.

How to proceed

1. Register your owner-key

On the website www.ilu-code.eu, you should register your company data and choose an owner-key. Upon payment of the registration fee, your code is registered and officially published in the ILU-Code Register. With your owner-key, you can directly identify your loading units: one single owner-key in combination with the freely chosen registration number allows you to mark up to 999,999 loading units.

2. Mark your units

For every newly purchased or already owned loading unit you may either ask the manufacturer to take care of the marking, or carry out it yourself for instance through self-adhesive labels that you can order on the ILU-Code website.

ILU-Code: three elements



5 Advance notification of an ITU consignment

The customer shall communicate the data displayed on the codification plate or on the containers (owner-key, series number, length, height and width).

6 Technical consultation concerning ITUs and options for loading on railway routes

Hupac's departments Fleet Management (FM) and Risk & Safety, HSEQ, Dangerous Goods, in cooperation with the relevant services for intermodal transport of the various railway operators, can be contacted for any further information by the manufacturers of ITUs and customers.

6.1 Services / Contacts for information

FM - Rolling Stock (rolling stock / codes / vehicles):

Mattia Vismara	tel. +41 58 8558340	mvismara@hupac.com
Michael John	tel. +41 58 8558301	mjohn@hupac.com
Olimpio Rivera	tel. +41 58 8558335	orivera@hupac.com

Safety, Dangerous Goods and Waste:

Fabio Contrafatto	tel. +41 58 8558070	fcontrafatto@hupac.com
Davide Tieghi	tel. +41 58 8558071	dtieghi@hupac.com



7 Combined transport (block trains without manoeuvre)

Goods loaded on semi-trailers, containers and swap bodies (ITUs).

7.1 Stresses during transport

- ① In the longitudinal direction (in both directions up to 1 g)
- ② In the transverse direction up to 0.5 g ($1 \text{ g} = 9.81 \text{ m/s}^2$)
- ③ Stresses in the vertical direction favour the displacement of goods during transportation

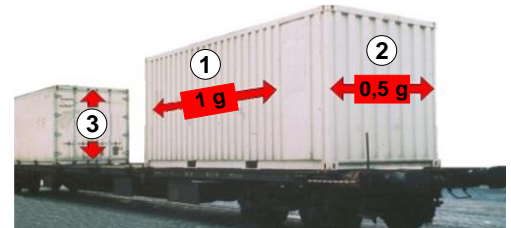

7.2 Conditions of the ITUs used for transport

- Cleaned floor
- In good condition and intact side walls, metal structures and canvas covers
- Locking devices of the doors and of the side walls in good working order
- It is forbidden to use fastenings to secure the load to the corner fittings or to the grip edges of ITUs.

7.3 Loading system

- Load the goods onto the whole available surface in a compact manner (with no free spaces) and secure them individually
- Distribute the bulk goods evenly and compactly on the whole loading surface
- Do not exceed the external dimensions of the ITU (any exception shall be agreed with all the parts involved in transport: RUs, operators of combined transport, terminal managers, etc.)
- Distribute the load uniformly, in both the longitudinal and transverse directions, in such a way that the ITU is balanced during the transshipment phase and cannot move out of the grip of the crane clamps
- Stacking is authorised only if the bottom layer occupies the entire loading surface
- The goods and loading system shall not cause any stresses to the ITU, in order not to jeopardise the train operation.

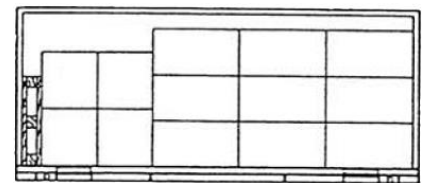

7.4 Load securing

To ensure stable loads, the single elements or stacks have to be assembled, e.g. through fastenings or thermo-contraction plastic sheeting.

The stacking of sacks shall be carried out in a cross or inwardly inclined form.

The goods which can be easily raised up due to air movements shall be protected against falling and lifting.

Goods which are not fastened to the side or front walls have to be secured by means of:

- direct or indirect fastenings
- stays
- pneumatic or padded cushions
- upright palletes or wooden panels
- inserts which improve the coefficient of friction.

It is recommendable to use the fixing devices of the loading units to grant their securing.

The stay support has to be inserted in such a way that the load pressure is distributed over the surface as much as possible.

This has to be done across the entire width of the load near the doors and at the front edges, possibly against the corner mounts.

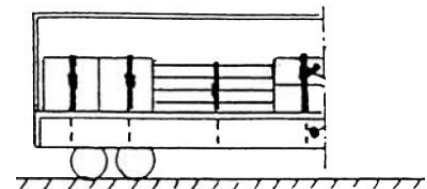

7.5 Securing only by means of canvas covers, roof arches and metal structures is not sufficient

Goods have to be secured against tipping by means of frames, stays or fastenings for approx. 3/4 of their height, where the supporting surface \textcircled{a} is at least:

- 6/10 in the longitudinal direction;
- 5/10 in the transverse sense of the height \textcircled{h} .

Cylindrically shaped goods have to be wedged to prevent their rolling.

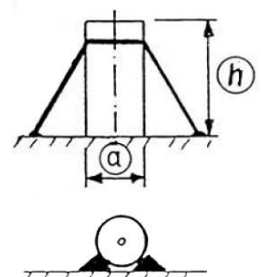

7.6 Loading examples

7.6.1 Sacks

- ① - overlapped stacking;
- ② - inclined towards their centre;
- ③ - on palettes stacked one on top of the other and secured with fastenings.

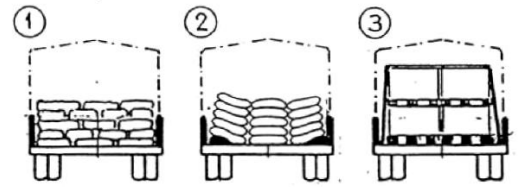

7.6.2 Boxes

- ④ - tied together;
- ⑤ - secured with indirect fastenings;
- ⑥ - use of vertical panels to prevent their transverse movement.

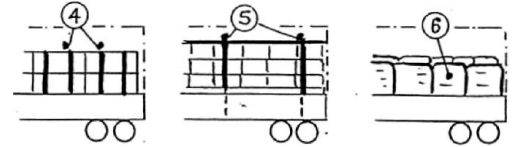

7.6.3 Paper rolls transversally positioned

- ⑦ - fix them with wedges (each wedge with at least 2 nails of 5 mm Ø);
- ⑧ - fasten them against lateral movement (e.g. with a series of mats).

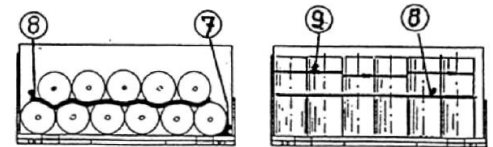

7.6.4 Standing paper rolls and barrels

- ⑧ - fasten them against displacement (e.g. with a series of mats);
- ⑨ - top layer to be fastened together in groups (to prevent slipping).

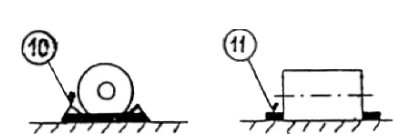

7.6.5 Coils transversally positioned

- ⑩ - load the coils onto saddles or chops with floor stays;
- ⑪ - fasten them to prevent lateral movement (e.g. with wooden blocks).

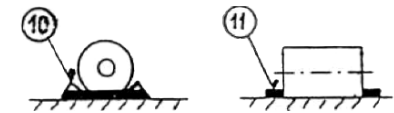

7.6.6 Panels, steel sheeting

- ⑫ - fastened in packs, maximum height 75 cm;
- ⑬ - stacked one atop the other, maximum height 1.25 m;
- ⑭ - insert joists between the packs;
- ⑮ - tie packs and stacks at least one metre apart (with 2 transverse fastenings) use both belts with a min. tear strength of 1400 daN and corner protections;
- ⑯ - secure against transverse movement (e.g. with joists or fastenings).

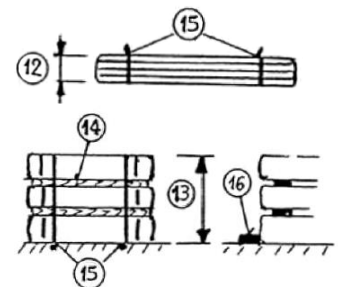

7.6.7 Pipes and steel profiles in bundles

- ⑰ - load them in a maximum of four layers;
- ⑱ - interspace the layers with joists 2 m apart having a cross-section of at least 60 cm (e.g. 15x4 cm, 12x5 cm);
- ⑲ - tie together the bundles at least two at a time;
- ⑳ - secure the load with at least 2 indirect fastenings, self-locking belts with a min. tear strength of 4000 daN.

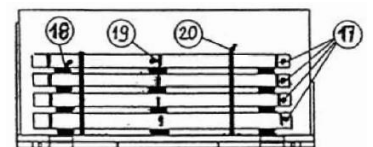

7.6.8 Scrap, waste paper (loose or bundled), powdery materials, sand and gravel

- ⑳ - load up to and not beyond the upper edge of the ITU;
 - cover the whole surface
 - waste paper, powdery materials, sand and gravel with canvas covers;
 - light scrap (sheeting, vehicle parts, cuttings, etc.) with synthetic or light metal netting;
- ㉑ - fix with ropes with tear strength ≥ 50 daN.

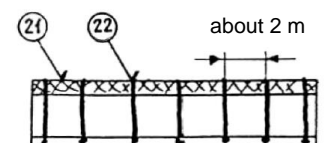



7.7 Canvas covers for covering the load

The canvas covers used to cover the load have to be resistant and hardly flammable.

They shall allow water to run off, avoiding the formation of puddles.

Canvas covers shall be secured with sufficient non-metallic fastenings, so that they cannot flutter during the journey and jeopardise the railway activity.

7.8 Special provisions for the loading of swap bodies / containers onto pocket wagons

- Loading units up to 40 feet in length with or without CSC approval plate may be loaded on all pocket wagons.
- Loading up to 40 feet in length with pictogram  and/or a CSC approval plate may be loaded on all pocket wagons.
- Loading units with the pictogram  may be conveyed on pocket wagons if the intermediate timbers or rolling beams on the solebar are in the active position.
- Loading units with the pictogram  may not be conveyed on pocket wagons.
- When transporting loading units of length groups 40 to 53 and 91 to 98 without a CSC plate and without one of the above pictograms, the intermediate timbers or rolling beams on the solebar should be put in the active position.



Meaning: pictogram for loading units wider than 2500 mm but with a setback of 2500 mm in the area of fixing pieces.

N.B.: Not all loading units have this pictogram, although this parameter is respected.

- Should the central supports be present, they have to be put in the active position.

8 Condition of the ITU

8.1 Regulations for the ITU

ITUs shall be sealed as instructed according to the CIM regulations.

8.2 Supplementary instructions for the loading of ITUs

8.2.1 Concentrated loads: coils, marble/granite blocks and other heavy goods

8.2.1.1 Coils

The loading of coils is permitted exclusively onto ITUs that are certified for this transport.

The position and maximal weight of coils on ITUs, which are defined by the manufacturer, shall always be complied with.

The loading of coils on non-authorized ITUs is strictly prohibited, since they can cause the floor to collapse. The coils shall be positioned in suitable tubs and secured against transverse movement, or positioned on saddles and secured against tilting and slipping.

In order to guarantee a correct weight repartition, it is important to respect the centring inside the tubs.

A special declaration, obtainable on request, has to be filled in for the consignments of coils from/to Italy.

For other types of goods with centred weight, the maximum floor bearing load has to be respected on the basis of the surface area occupied by the load.

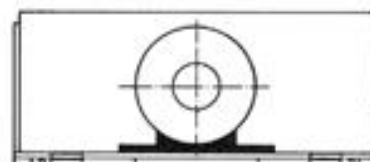

8.2.1.2. Marble/granite blocks

The loading of marble/granite blocks onto flat containers has to be carried out according to the following instructions:



- ① Blocks have to be loaded by stretching them out in 1 or 2 layers, distributing them as much as possible over the whole loading surface, with or without free spaces.
- ② They shall be stabilised with 2 or 4 soft-wood interlayers.
- ③ They shall be tied together to form a loading unit with at least 2 fastenings (min. breaking strength 1400 daN).
- ④ The quantity of indirect fastenings shall be adjusted according to the weight of the goods (min. breaking strength 1400 daN).
- ⑤ Fastenings shall have safety hooks against accidental detachment.
Hooks without anti-detachment safety have to be locked at the anchorage point, for example with clamps, wire, etc.



8.2.2 Fastening

In exceptional cases it is allowed to hook up external belts to fasten the loading on the sides or on the frame only if these are intact, well stretched and situated in points which do not disturb the transshipment of the ITU.



8.2.3 Securing of standing paper rolls

Paper rolls which are loaded in one, respectively two layers, have to be secured as follows. Each roll, respectively each stack of rolls, has to be secured with ratchet lashing belts against indirect fastening.

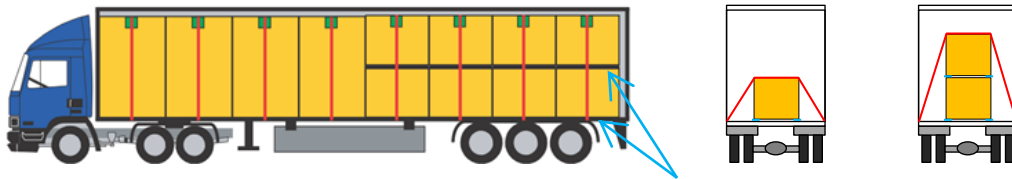

Non-slip mats with a minimum friction coefficient of 0.7 have to be put under each roll and, in case of stacked rolls, also between the rolls.



Option 1: Each layer, respectively each double layer (stack of rolls), is secured against displacement with indirect fastening.

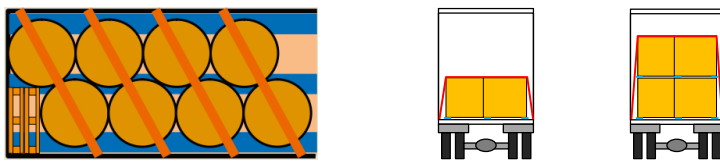

Empty pallets stacked up at the end wall as spacers

According to our experience this kind of fastening of the upper layer is not sufficient to ensure transport safety. Groups of 2, 3 or 4 rolls of the upper layer have to be tied together.

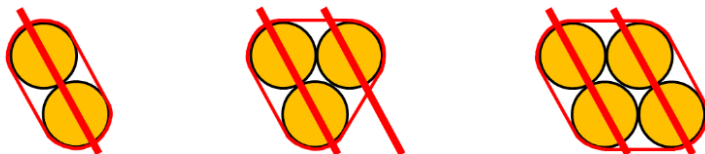

Option 2: Each roll, respectively each stack of rolls, is secured against displacement through indirect fastening. *Optimal fastening!!*

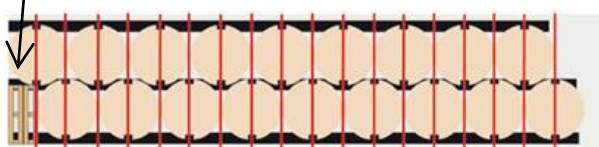
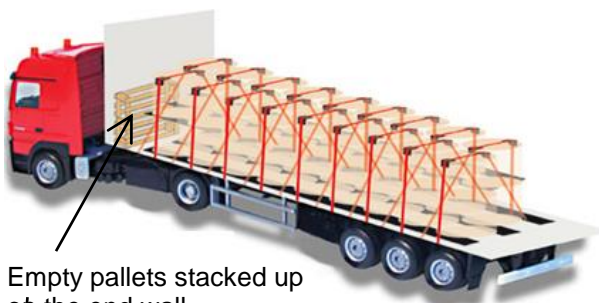

Non-slip mats with a minimum friction coefficient of 0.7

Protective edges
Indirect fastening

8.2.4 Displacement of the load

The goods loaded on ITUs have to be well fastened, in order to avoid any displacement during the trip, which might seriously endanger the railway activity.
ITUs with a swollen part of the tarpaulin due to the displacement of the load are not allowed to transportation.



8.2.4.1. Wire rod rolls

To avoid the displacement of goods during transportation, the loading of the wire rod rolls has to be carried out in a transverse way according to the following points:

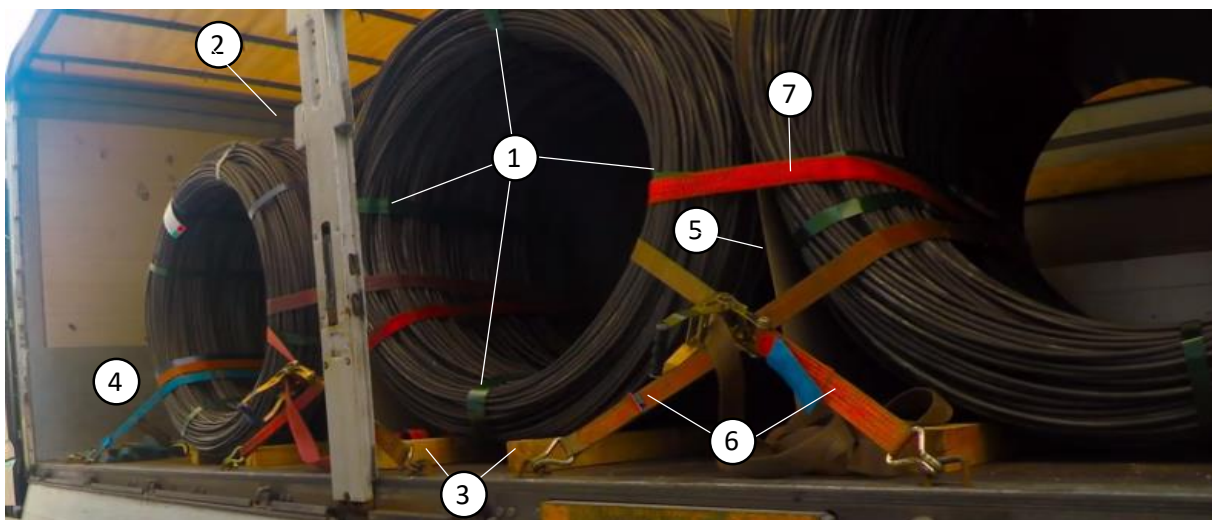

- ① The compacting of wire rod rolls shall be carefully carried out, in order to ensure good stability. Each roll is held together by at least 4 fastenings of annealed steel wire or steel straps (min. breaking strength: 1400 daN) regularly distributed over the whole circumference of the roll. No fastening can be loose or broken.

The wire rod rolls are:

- ② centrally loaded with respect to the longitudinal axis of the wagon;
- ③ leaned against the joists over the whole width;
- ④ in contact with the head wall or spaced by means of 2 joists nailed to the first transverse joist;



- ⑤ leaned together with a carton;
- ⑥ secured with 2 fastenings (min. breaking effort 2500 daN);
- ⑦ tied together to form a loading unit with 1 fastening (min. breaking effort 2500 daN).

8.2.5 Incorrectly distributed load

In case of an excessive weight difference in the transverse direction, the wagon is shunted out from the train and the goods inside the loading unit have to be rearranged.



In both cases, the excess weight on the left side triggered an alarm by means of a weight measuring system on the railway route. This because of the difference in the transverse weight.

The main instructions regarding the loading of goods are mentioned in article 7 of this document.

8.2.6 Hermetic sealing of ITUs / Presence of goods outside ITUs

As a general rule, loading units should not have any leak (liquid or solid).

It's up to the shipper to make the loading unit hermetic before delivering it to the loading terminal. Loading units with leak (see pictures below), have to be rejected during the check-in at the terminal.



There shouldn't be any material on the outer side of the loading unit. In any case it should be removed before the loading unit is delivered to the loading terminal.



8.2.7 Flexitank

Flexitanks are plastic "bags" (PVC or polyurethane or others depending on the type) for transporting liquid loads, which are fitted inside a standard 20' container.

They normally have a capacity of between 18,000 and 25,000 litres, depending on the specific weight of the product. Due to the high stresses during transport and in order to avoid deformation of the side walls and thus ensure safe transport, the maximum permitted weight of goods is limited **to 18 tonnes**.



From an operational and economic point of view, this solution makes it possible to transform a container into a tank container suitable for transporting both foodstuffs and non-hazardous chemicals. This with considerable advantages.

Here is a list of products that are easily transported using flexitanks:

FOOD:

Olive oil (vegetable oils in general)

Wine

Drinking water

Molasses

Fruit juices (concentrate)

Fish oil

CHEMICAL/INDUSTRIAL PRODUCTS:

Natural or synthetic latex

Glycerine

Detergents

Water-based paints

Lubricants

Mineral oils

Most flexitanks have obtained various approvals/certifications including:

- Food and Drug Administration (US),
- ISO 9001-2008,
- HACCP,
- Container Owner Association,
- Religious certifications: Kosher and Halal.

The assembly of a flexitank is usually carried out by a team of fitters appointed by the companies that offer this service to forwarding companies; it is a fairly quick operation that can take less than an hour.

Once filled, the flexitank looks like a huge pillow.



Here are some recommendations to follow when setting up and loading:

- Check the overall condition of the container as it is usually done for every consignment.
- Clean the floor with a broom.
- Check that there are no nails, splinters, glass or any other sharp and/or pointed objects that could damage the flexitank.
- Apply protective cardboard or plastic sheeting to the floor and corrugated walls, using an adhesive tape, up to a height of approx. 1.5 m.
- Place the flexitank inside the container by carefully unrolling it and checking its integrity.
- Take care not to place your hands, feet or knees on tools that may have been placed on the flexitank during set-up.
- Mount the reinforcement bulkhead correctly.
- Carry out the loading gradually, paying attention to any leaks, etc.
- Fill the flexitank according to the manufacturer's instructions, observing the tolerances regarding underfill and overfill.
- Pay attention to the correct closing of the discharge valve.
- Complete the loading operations, remembering to affix the adhesive labels on the left door of the box, indicating that there is a flexitank in the container.



8.2.8 Containers and stacked swap bodies

The transport of this mode of loading is permitted in accordance with the UIC Loading Guidelines.

Stacked loading units must have ISO top corner blocks and CSC plates.

This loading mode may only be conveyed on wagons in combined transport, respecting the loading gauge and only if they are of the same type, the same length and if each of them is joined together with four intermediate supports equipped with a twist lock of the same model, or if they are bolted together:

- in the case of automatic or semi-automatic locking systems, the locking status must be identifiable visually;
- in the case of manual locking systems, the locking lever in the closed position must be secured in such a way as to exclude any spontaneous or unintentional release;
- should connecting pieces without twist locks be used, the stacked loading units must be bound together using at least two bindings with edge protection for the sharp edges. Only securing straps may be used as bindings.

N.B.: The heaviest loading unit shall always be loaded in the bottom position.



8.3 Regulations for all the ITUs fitted with tarpaulin

Slats, belts, bars and supports

The following ITUs are not allowed:

- with less than 3 horizontal slats (on longitudinal and rear sides) between the belts;
- with incorrectly fitted support bars;
- with missing or bent tarpaulin upper supports.



Holes and cuts in the tarpaulin

Tarpaulins shall be in a safe condition for transportation; any cuts should be glued or welded.



Belts

All the eyelets have to be taut. Where there is no eyelet, the belt should be secured by means of a metallic wire/plastic strap.

Tarpaulin eyelets / Truck cable

The distance among the tarpaulin eyelets shall not exceed 20 cm; the one close to the bars /door latches 30 cm. The truck cable shall be taut through all the eyelets. Not more than 3 eyelets, and not consecutively placed, should be missing.



Zigzag holders

Tarpaulin retention systems arranged in a zigzag manner are not permitted, unless a truck cable is drawn tautly through the eyelets.

Only one eyelet may be omitted or missing.



ITUs with "curtainsider" tarpaulins

All the fastening belts have to be attached to the side member of the ITU and tensioned through the appropriate device. Only one fastening belt per side may be damaged, and this must not hang down. The sliding parts of the tarpaulin have to be closed and well-secured. When securing the tarpaulin of the type curtainsider, it is not necessary to draw an additional securing rope through the tarpaulin eyelets of the tension belts.

ITUs carrying the pictograms "Code XL" or "XL" on the codification plate are suitable for railway transport up to a maximum speed of 140 km/h.

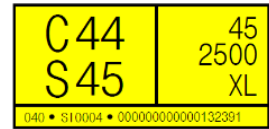



Important information for forwarding companies, terminals and railway undertakings

In loading units with tarpaulin structures like "curtainsider", the sliding part of the tarpaulin has to be closed / taut on both sides according to the manufacturer's instructions. The same holds for roofs. The forwarding company is responsible for their correct closing.



Constructional parts that have to be checked. Example semi-trailer.

-  All the stretching tubes of the tarpaulin have to be well inserted in the appropriate rooms.
-  The fixing means have to be correctly fastened.
-  The belts have to be fastened and tightened.



The control of the visible part of the loading unit should be carefully carried out by the railway undertaking at the terminal check-in and before the train departure, in order to avoid the opening of the sliding parts of the tarpaulin during the trip (see picture).

In order to avoid the complete opening of the sliding parts of the tarpaulin during the trip because of the unfastening of the roll-up rod of the tarpaulin, we recommend the assembly of 4 longitudinal belts (one for each corner, see pictures below) in case of semi-trailers and swap bodies with a greater length of 40'. This is also requested for the new ITUs according to the UIC/IRS regulations.

Front part



Rear part



The keeper is responsible for guaranteeing the correct maintenance of his loading unit and replacing the damaged or worn bolting parts of the sliding parts both of the tarpaulin and of the roof. In order to guarantee a safe transport, the parts used for the fastening of the covers (see pictures below) must be in good condition.

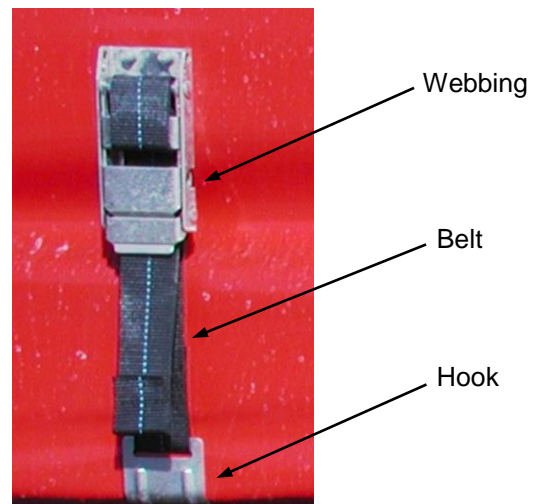
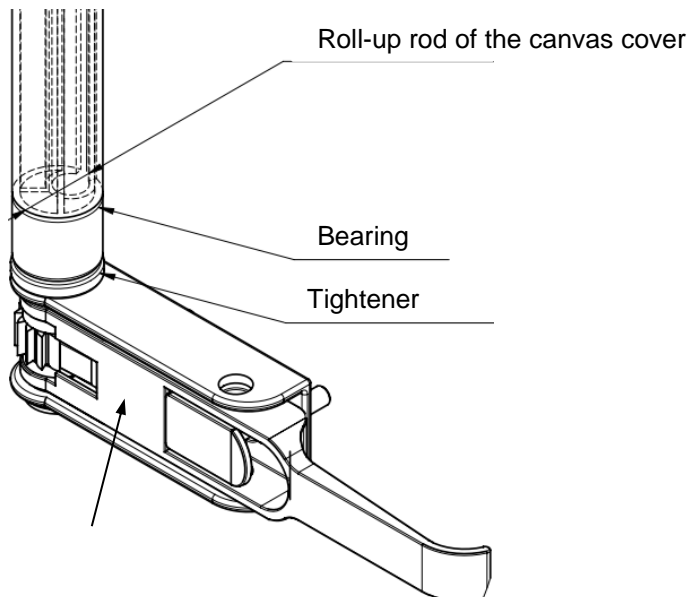

ITUs with vertically adjustable tarpaulins

The structures with vertically adjustable tarpaulins shall be labeled with 2 codification plates. Only one of these can be associated to the corresponding corner height (visible through a window of the tarpaulin) or respectively with a visual identification system.



In case of structures with vertically adjustable tarpaulins and only one authorized height for rail transport, there must be a univocal identification system (for example by means of corresponding colored stripes).

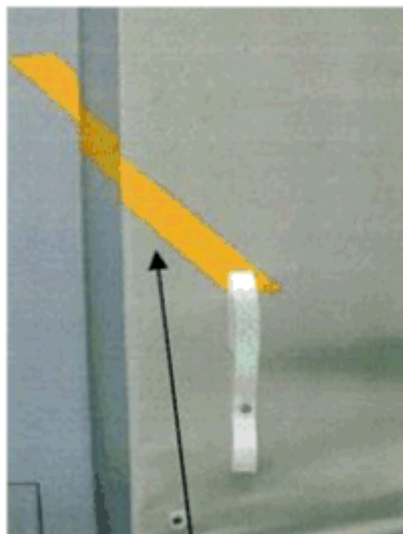

N.B.: In rail transport, the coloured strip on the tarpaulin must be aligned or below the one on the ITU door post (pillar).
The lack of one of these two strips might cause the refusal of the ITU to the load, as it is not possible to verify the observance of the profile indicated on the codification plate.

Loading units with reinforced tarpaulins

Loading units with reinforced tarpaulins for the transportation of goods subject to settling must have one of the following additional pictograms affixed to the front wall or next to the codification plate.



or



old version

new version

- Goods loaded in accordance with the applicable load certificate can be in contact with the tarpaulin (e.g. car tyres with load certificate, etc.)
- Good and securing methods cannot come into sharp edge contact with the tarpaulin or damage it.
- The loading unit shall not exceed the maximum width indicated on the codification plate.



8.4 Regulations for tank containers

Valves, caps and pipes

Valves must be closed and filler caps must be fixed. There must be no leak of liquids or gas from the tank.



Covers / latches

All tank covers must be closed and well secured.



Insulation, tank support frame

The insulation must be fixed because of safe transport reasons. Both the supporting frame and the tank must not be buckled or show any cracks that might endanger transportation. In this respect, multi-chamber tanks **must** be loaded uniformly also by respecting the maximum load specifications for each single chamber.



Electrical power signs

ITUs with access ladders must bear a pictogram indicating "Danger: electrical current".



or



8.5 Provisions for Open Top containers

The goods shall remain below the upper part of the ITU, in order to avoid any contact with the canvas cover.

Holes and cuts in the tarpaulin



Tarpaulins shall be in good repair for a secure transport; any cuts both in the upper and in the side part of the tarpaulin shall be glued with adhesive tapes or welded.

To ensure transport safety, the parts used for the correct fastening of the tarpaulin shall be in good repair.

Belt tensioner

They shall be undamaged and tightened in a stable way.

Belts

They shall not be missing or deteriorated.

They shall be tightened with the corresponding belt tensioner.

Tarpaulin eyelets / cable

The maximum distance among the eyelets of the tarpaulin shall not exceed 20 cm and the cable/rope shall be tightened through all the eyelets.

Longitudinal bar

It shall be inserted into the tarpaulin and not project beyond the outer part of the ITU.

8.6 Hazardous Goods Transport

The transport of hazardous goods is subject to the respective international regulations.

ADR – road

RID – rail

IMDG – sea

ADN – river

IATA – air

In addition to these, there are regulations in the individual countries which may be more or less restrictive than the international ones.





Hupac has defined a list of hazardous goods that cannot be transported on its trains or that are not accepted in some of its terminals. For any further information, please visit our website www.hupac.com

It is the customer's responsibility to deliver loading units that comply with the above-mentioned international transport rules, paying specific attention to:

- the condition of the loading unit (maintenance, overhauls, etc.);
- the condition of the load;
- staff training and necessary authorizations (for example ADR licence);
- labelling;

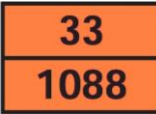
- completeness of the data and of the required documentation;
- a prompt pick up of the loading units from the terminals;
- a prompt intervention in case of safety issues (loss of product, leak, etc.).

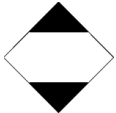
8.6.1 Labelling regulations for vehicles containing hazardous goods

 <p>Danger sign</p>	<p>Danger signs must be applied on all the 4 sides of the vehicle.</p> <p>For semi-trailers which are separated from the tractor unit, they must be affixed on both sides of the trailer, unless the orange-coloured plates have already been affixed.</p>	<p>cm 25 x 25</p> <p>cm 25 x 25</p>
 <p>Orange plates</p>	<p>Orange-coloured plates must be displayed on two sides of the tank / container.</p> <p>In case of multi-chamber tanks, the label must be displayed on the two longitudinal axes.</p> <p>Semi-trailers, which are separated from the tractor unit, have an orange-coloured plate without figures on the front and the rear part, unless the danger sign has been affixed.</p>	<p>cm 40 x 30 digits 10 cm</p>
	<p>Containers labelled according to the IMDG Code can be accepted. The labels have to be in very good condition (colour, size, etc.). The electronic documents (train list, etc.) must report the following remark: "CARRIAGE ACCORDING TO 1.1.4.2.1".</p>	<p>cm 25 X 25</p> <p>cm 30 x 10</p>
	<p>ENVIRONMENTALLY HAZARDOUS SUBSTANCES</p> <p>This mark must be affixed on the 4 sides of the loading unit if the substance is subject to the ADR/RID provisions, paragraph 2.2.9.1.10.</p> <p>ITUs on the 4 sides, semi-trailers on the 2 longitudinal sides.</p>	<p>cm 25 x 25</p>
	<p>LIMITED QUANTITY (LQ)</p> <p>When provided for by the ADR/RID provisions, the mark for a "limited quantity" consignment (≥ 8 t) must be affixed on the 4 sides of the loading unit.</p> <p>ITUs on the 4 sides, semi-trailers on the 2 longitudinal sides.</p>	<p>cm 25 x 25</p>
	<p>SUBSTANCES TRANSPORTED AT ELEVATED TEMPERATURES</p> <p>This symbol must be displayed when substances are transported in a liquid state at an equal or higher temperature ≥ than 100°C or in the solid state, at an equal or higher temperature ≥ than 240°C.</p> <p>ITUs on the 4 sides.</p>	<p>cm 25 x 25</p>

The orange-coloured plates and danger labels must be attached in such a way that they do not get detached or damaged during the journey. They must be weatherproof.

8.6.2 Transport of Class 1 materials

The transport of Class 1 materials is subject to the above-mentioned regulations and to special authorisations issued by authorities (ministries, regional administrations, others).

The documentation that is delivered to the terminal shall also include a copy of these documents (when requested), the absence or incompleteness of which may cause the consignment to be stopped.

It is essential to notify the terminal of these shipments at least 24 hours in advance.

8.6.3 Transport of Class 7 materials

Hupac transports no materials of this class on its trains.

8.6.4 Description N.O.S. (Not Otherwise Specified)

As far as the ADR/RID goods departing from Italy are concerned, the statement of the technical name of the product N.O.S. has to be inserted, according to RID, chapter 5.4, paragraph 3.1.2.8.1.1. In case of consignments with destination abroad, this shall be issued not only in Italian, but also in one of the three languages provided for by RID (French, English or German).

8.6.5 Transport of lithium-metal batteries

UN 3090	LITHIUM-METAL BATTERIES
UN 3091	LITHIUM-METAL BATTERIES CONTAINED IN A DEVICE OR LITHIUM-METAL BATTERIES PACKED IN A DEVICE
UN 3480	LITHIUM-ION BATTERIES
UN 3481	LITHIUM-ION BATTERIES CONTAINED IN A DEVICE OR LITHIUM-ION BATTERIES PACKED IN A DEVICE



The ADR-RID consignments of lithium batteries involve different provisions which are mainly distinguished as follows:

- A. Exempted consignment according to the application of the special provision 188 of chapter 3.3 ADR-RID.
- B. Consignment under full ADR-RID regime for all cases where the special provision 188 of chapter 3.3 ADR-RID cannot be complied with.
- C. Waste consignment.

The definition of the regime to be applied shall be established by our customer (if necessary with the involvement of the manufacturer, the carrier or the packer). The technical characteristics, packaging methods and tests carried out for homologated packages shall be verified.

A. Exempted consignments with application of the special provision 188 of the chapter 3.3 ADR-RID

Please find here below the content of the special provision 188 (ADR-RID 2021) which shall be complied with, in order to have full exemption.

188 Cells and batteries offered for carriage are not subject to other provisions of RID if they meet the following:

- (a) For a lithium metal or lithium alloy cell, the lithium content is not more than 1 g, and for a lithium-ion cell, the Watt-hour rating is not more than 20 Wh;

NOTE: When lithium batteries in conformity with 2.2.9.1.7 (f) are carried in accordance with this special provision, the total lithium content of all lithium metal cells contained in the battery shall not exceed 1.5 g and the total capacity of all lithium ion cells contained in the battery shall not exceed 10 Wh (see special provision 387).

- (b) For a lithium metal or lithium alloy battery the aggregate lithium content is not more than 2 g, and for a lithium-ion battery, the Watt-hour rating is not more than 100 Wh. Lithium ion batteries subject to this provision shall be marked with the Watt-hour rating on the outside case, except those manufactured before 1 January 2009;

NOTE: When lithium batteries in conformity with 2.2.9.1.7 (f) are carried in accordance with this special provision, the total lithium content of all lithium metal cells contained in the battery shall not exceed 1.5 g and the total capacity of all lithium ion cells contained in the battery shall not exceed 10 Wh (see special provision 387).

- (c) Each cell or battery meets the provisions of 2.2.9.1.7 (a), (e), (f) if applicable and (g);

- (d) Cells and batteries, except when installed in equipment, shall be packed in inner packagings that completely enclose the cell or battery. Cells and batteries shall be protected so as to prevent short circuits. This includes protection against contact with electrically conductive material within the same packaging that could lead to a short circuit. The inner packagings shall be packed in strong outer packagings which conform to the provisions of 4.1.1.1, 4.1.1.2 and 4.1.1.5;

- (e) Cells and batteries when installed in equipment shall be protected from damage and short circuit, and the equipment shall be equipped with an effective means of preventing accidental activation. This requirement does not apply to devices which are intentionally active in carriage (radio frequency identification (RFID) transmitters, watches, sensors, etc.) and which are not capable of generating a dangerous evolution of heat. When batteries are installed in equipment, the equipment shall be packed in strong outer packagings constructed of suitable material of adequate strength and design in relation to the packaging's capacity and its intended use unless the battery is afforded equivalent protection by the equipment in which it is contained;

- (f) Each package shall be marked with the appropriate lithium battery mark, as illustrated in 5.2.1.9.

This requirement does not apply to:

- (i) packages containing only button cell batteries installed in equipment (including circuit boards); and
(ii) packages containing no more than four cells or two batteries installed in equipment, where there are not more than two packages in the consignment;

When packages are placed in an overpack, the lithium battery mark shall either be clearly visible or be reproduced on the outside of the overpack and the overpack shall be marked with the word "OVERPACK". The lettering of the "OVERPACK" mark shall be at least 12 mm high.

NOTE: Packages containing lithium batteries packed in conformity with the provisions of Part 4, Chapter 11, packing instructions 965 or 968, Section IB of the ICAO Technical Instructions that bear the mark as shown in 5.2.1.9 (lithium battery mark) and the label shown in 5.2.2.2.2, model No. 9A shall be deemed to meet the provisions of this special provision.

- (g) Except when cells or batteries are installed in equipment, each package shall be capable of withstanding a 1.2 m drop test in any orientation without damage to cells or batteries contained therein, without shifting of the contents so as to allow battery to battery (or cell to cell) contact and without release of contents; and
- (h) Except when cells or batteries are installed in or packed with equipment, packages shall not exceed 30 kg gross mass.

As used above and elsewhere in RID, "lithium content" means the mass of lithium in the anode of a lithium metal or lithium alloy cell. As used in this special provision "equipment" means apparatus for which the lithium cells or batteries will provide electrical power for its operation.

A new mark has been created for lithium batteries and equipment containing them, when transport is exempted.

* = Position for the UN number

** = Position for the handy number, should further information be needed.

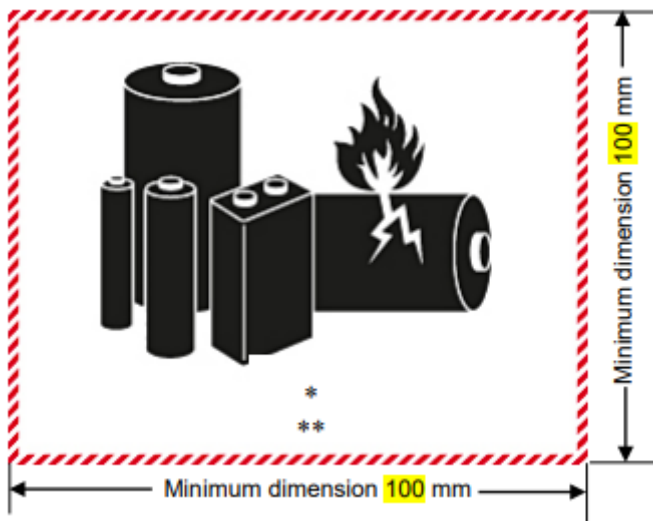

The mark does not apply to:

- (i) packages containing only button cells installed in devices (electronic boards included); and
- (ii) packages containing no more than four cells or two batteries installed in devices, with a maximum of two packages per consignment.

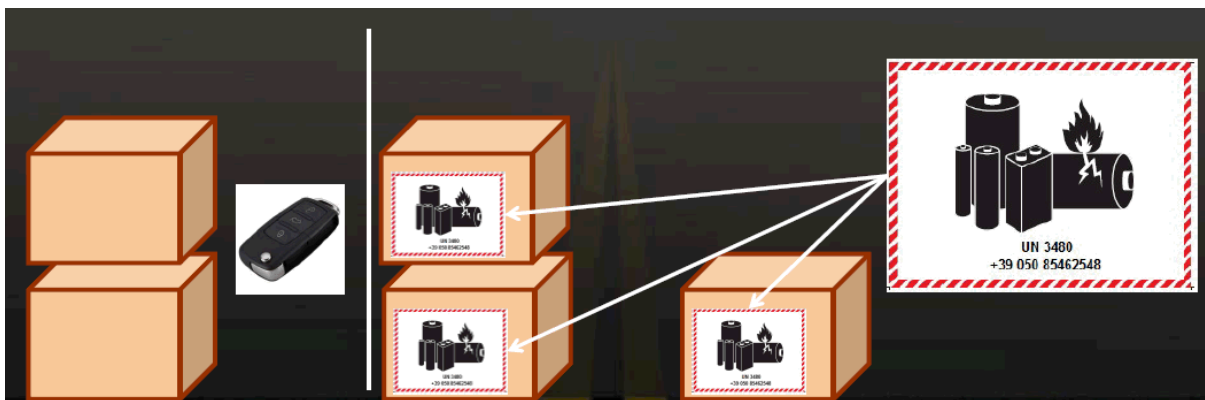

B. Consignment under full ADR-RID regime

The consignments of lithium batteries under full ADR-RID regime shall comply with the indications in 5.4.1.1 c) for the preparation of the transport document.

It is specified that for lithium batteries UN 3090, UN 3480, UN 3091, UN 3481, the class number "9" and not the label model 9A shall be stated on the transport document.

See example below regarding the transport document (class 9 is indicated and not the 9A label affixed to the packaging.)

A 3481, LITHIUM-ION BATTERIES CONTAINED IN A DEVICE, 9, (E)

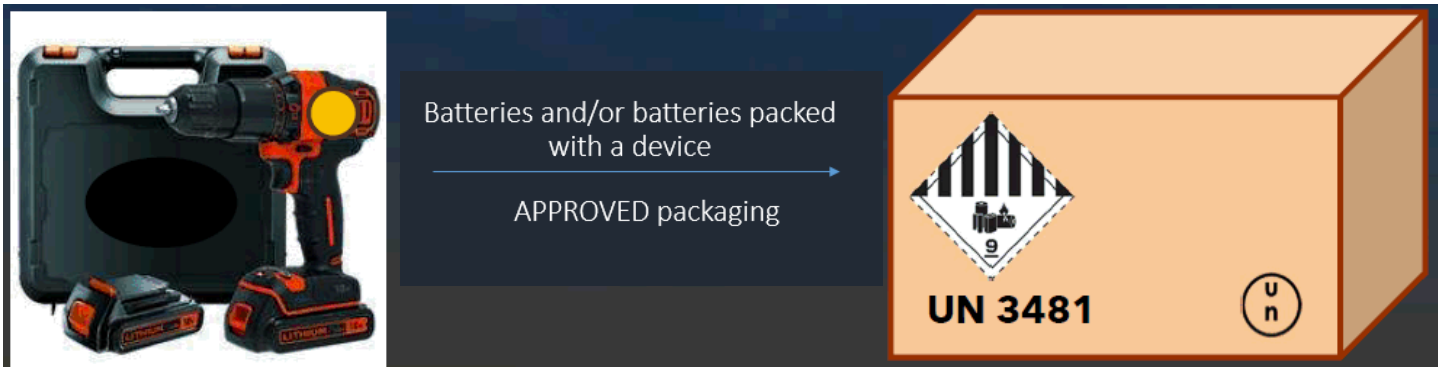

Chapter 3.2 ADR-RID contains the special provisions and packing instructions that shall be complied with.

UN No.	Name and description	Class	Classification code	Packing group	Labels	Special provisions	Limited and excepted quantities	Packaging				Portable tanks and bulk containers		RID Tanks		Transport category	Special provisions for carriage			Colis express (express parcels)	Hazard identification No.
								Packing instructions	Special packing provisions	Mixed packing provisions	Instructions	Special provisions	Tank code	Special provisions	Packages		Bulk	Loading, unloading and handling			
	3.1.2	2.2	2.2	2.1.1.3	5.2.2	3.3	3.4/3.5.1.2	4.1.4	4.1.4	4.1.10	4.2.5.2, 7.3.2	4.2.5.3	4.3	4.3.5, 6.8.4	1.1.3.1(c)	2	7.2.4	7.3.3	7.5.11	7.6	5.3.2.3
3480	LITHIUM ION BATTERIES (including lithium ion polymer batteries)	9	M4		9A	188 230 310 348 376 377 387 636	0 E0	P903 P908 P909 P910 P911 LP903 LP904 LP905 LP906							2					CE2	90
3481	LITHIUM ION BATTERIES CONTAINED IN EQUIPMENT or LITHIUM ION BATTERIES PACKED WITH EQUIPMENT (including lithium ion polymer batteries)	9	M4		9A	188 230 310 348 360 376 377 387 390 670	0 E0	P903 P908 P909 P910 P911 LP903 LP904 LP905 LP906							2					CE2	90

The customer is responsible for checking which packing instruction is actually needed or applies. Please find below an example of packing instruction P903 contained in ADR-RID.

C. Transport of lithium batteries as waste under ADR-RID regime (Packing Instruction P908 or P909).

Customers are requested to check which packing instruction should be used (P908 or P909).

The following is a non-exhaustive list of packing instructions. The customer is requested to refer to the contents of ADR-RID.

Packing instruction P908 applies to damaged or defective lithium-ion or lithium metal batteries with UN numbers 3090, 3091, 3480 and 3481, including those contained in a device.

Packing instruction P909 applies to UN numbers 3090, 3091, 3480 and 3481 being carried for disposal or recycling, whether or not mixed with other non-lithium batteries.

In accordance with the special provision 377 ADR-RID, lithium-ion batteries and lithium metal batteries as well as the devices containing such batteries being transported for disposal or recycling reasons, whether or not mixed

with other non-lithium batteries, may be packed in accordance with the packing instruction P909 of 4.1.4.1 ADR-RID.

P 903	PACKING INSTRUCTION	P 903
<p>This instruction applies to UN Nos. 3090, 3091, 3480 and 3481.</p>		
<p>For the purpose of this packing instruction, "equipment" means apparatus for which the lithium cells or batteries will provide electrical power for its operation.</p> <p>The following packagings are authorized provided that the general provisions of 4.1.1 and 4.1.3 are met:</p> <p>(1) For cells and batteries:</p> <ul style="list-style-type: none"> Drums (1A2, 1B2, 1N2, 1H2, 1D, 1G); Boxes (4A, 4B, 4N, 4C1, 4C2, 4D, 4F, 4G, 4H1, 4H2); Jerricans (3A2, 3B2, 3H2). <p>Cells or batteries shall be packed in packagings so that the cells or batteries are protected against damage that may be caused by the movement or placement of the cells or batteries within the packaging.</p> <p>Packagings shall conform to the packing group II performance level.</p> <p>(2) In addition for cells or batteries with a gross mass of 12 kg or more employing a strong, impact resistant outer casing, and assemblies of such cells or batteries:</p> <ul style="list-style-type: none"> (a) Strong outer packagings; (b) Protective enclosures (e.g., fully enclosed or wooden slatted crates); or (c) Pallets or other handling devices. <p>Cells or batteries shall be secured to prevent inadvertent movement, and the terminals shall not support the weight of other superimposed elements.</p> <p>Packagings need not meet the requirements of 4.1.1.3.</p> <p>(3) For cells or batteries packed with equipment:</p> <p>Packagings conforming to the requirements in paragraph (1) of this packing instruction, then placed with the equipment in an outer packaging; or</p> <p>Packagings that completely enclose the cells or batteries, then placed with equipment in a packaging conforming to the requirements in paragraph (1) of this packing instruction.</p> <p>The equipment shall be secured against movement within the outer packaging.</p> <p>(4) For cells or batteries contained in equipment:</p> <p>Strong outer packagings constructed of suitable material, and of adequate strength and design in relation to the packaging capacity and its intended use. They shall be constructed in such a manner as to prevent accidental operation during carriage. Packagings need not meet the requirements of 4.1.1.3.</p> <p>Large equipment can be offered for carriage unpackaged or on pallets when the cells or batteries are afforded equivalent protection by the equipment in which they are contained.</p> <p>Devices such as radio frequency identification (RFID) tags, watches and temperature loggers, which are not capable of generating a dangerous evolution of heat, may be carried when intentionally active in strong outer packagings.</p> <p>NOTE: For carriage in a transport chain including air carriage, these devices, when active, shall meet defined standards for electromagnetic radiation to ensure that the operation of the devices does not interfere with aircraft systems.</p> <p>(5) For packagings containing both cells or batteries packed with equipment and contained in equipment:</p> <ul style="list-style-type: none"> (a) For cells and batteries, packagings that completely enclose the cells or batteries, then placed with equipment in a packaging conforming to the requirements in paragraph (1) of this packing instruction; or (b) Packagings conforming to the requirements in paragraph (1) of this packing instruction, then placed with the equipment in a strong outer packaging constructed of suitable material, and of adequate strength and design in relation to the packaging capacity and its intended use. The outer packaging shall be constructed in such a manner as to prevent accidental operation during carriage and need not meet the requirements of 4.1.1.3. <p>The equipment shall be secured against movement within the outer packaging.</p> <p>Devices such as radio frequency identification (RFID) tags, watches and temperature loggers, which are not capable of generating a dangerous evolution of heat, may be carried when intentionally active in strong outer packagings.</p> <p>NOTE: For carriage in a transport chain including air carriage, these devices, when active, shall meet defined standards for electromagnetic radiation to ensure that the operation of the devices does not interfere with aircraft systems.</p>		
<p>Additional requirement</p> <p>Cells or batteries shall be protected against short circuit.</p>		

These batteries are not subject to the provisions of 2.2.9.1.7 (a) to (g).

Packages shall be marked 'LITHIUM BATTERIES FOR DISPOSAL' or 'LITHIUM BATTERIES FOR RECYCLING'.

Batteries identified as damaged or defective shall be transported in accordance with the special provision 376.

Additional requirements:

Batteries shall be protected against short circuits.

Metal packaging shall be provided with a non-conductive material coating (e.g. plastic).

Batteries designed or packaged to avoid any risks of short circuits and dangerous heat development. E.g:

- individual protection of battery clips;
- internal packaging to avoid contact among batteries;
- batteries with recessed clips;
- use of non-conductive padding material to fill the gap among the batteries.

Damaged batteries (special provision 376, chapter 3.3 ADR-RID) - Packing instruction P911

Products and batteries which under normal transport conditions are liable to rapidly disintegrate, to react dangerously, to produce a flame or dangerous heat or to give off toxic, corrosive or flammable gases or vapours shall be packed and carried in accordance with packing instruction P911. Alternative packing and/or carriage conditions may be authorized by the relevant authority of any contracting party to ADR which may also recognize an approval issued by the relevant authority in a country which is not a contracting party to ADR. As appropriate, a copy of the approval of the relevant authority shall accompany the consignment.

Labelling of loading units carrying lithium batteries

When labelling loading units, danger label 9A can be used (see example below). This label has been specially designed for the transport of lithium batteries.

When transporting swap bodies and containers, the label shall be placed on all 4 sides (for consignments both with and without sea route).

When transporting semi-trailers, 2 labels (1 on each side - without sea transport) and 4 labels (1 on each side in case of sea transport) shall be provided.



8.6.6 Control of loading units and drivers

Spot checks are expected to be carried out on road vehicles (tractor truck included) that carry dangerous goods, in order to verify the presence of protective devices for the driver and for the vehicle according to ADR. An additional control regards drivers who have to show their ADR licence.

8.6.7 Temporary storage of ITUs with dangerous goods

The temporary storage of ITUs containing dangerous goods in terminals is allowed only for the phases concerning transportation (departure, arrival or transshipment). No other storage is allowed.

8.7 Transport of waste

The transport of waste is allowed if the relevant regulations (CE) no. 1013-2006 and further requirements are complied with.

For each new (hazardous) waste consignment necessitating a notification, Hupac requires the transmission of a copy of the documentation to the e-mail address waste@hupac.com:

- notification document (Annex IA);
- list of carriers;
- transport route;
- chemical analysis of the waste.

The whole documentation shall be sent by Hupac to the involved railway undertakings.

The railway undertakings examine the documentation and confirm the transport possibility regarding the requested traffic connection/route.

Hupac records the notification data in its computer system and informs the carrier about the possibility of sending the units to the departure terminal.

Customers are requested to respect this process in order to avoid rejection when accepting units at the terminal and/or delays in departure.

The required transport documents issued by the relevant authority shall be correctly filled in (in each field), paying particular attention to the parts mentioned below.

- Annex I A (copy to be handed over)

- Annex I B

Write the correct and complete data in the different fields by paying particular attention to the fields **8 a, b, c** of the concerned freight carriers and, should they be more than 3, attach the corresponding annex.

- Annex VII (original)

Write the correct and complete data in the different fields by paying particular attention to the fields **5 a, b, c** of the concerned freight carriers and, should they be more than 3, attach the corresponding annex.

Should it be required by the relevant procedures, the above-mentioned documents have to be shown at the counter when delivering the container to the terminal.

This procedure concerns the transport of hazardous and non-hazardous waste.

In all cases, the EWC code (European Waste Code) shall be indicated in the transport document.

In the case of waste classified as ADR/RID, the labelling rules for containers are the same as the ones for the transport of hazardous goods.

The delivered vehicles shall not show any kind of leak and even any residuals on the external parts of the ITU. Vehicles that don't fulfill these conditions won't be accepted until they have been settled.

The label with an **R** (rifiuto pericoloso – dangerous waste) on yellow background is valid only for Italy. On the German territory the label shows an **A** (Abfall - waste) on white background. This should be covered or removed when the vehicle is empty.

8.8 Regulations for all the ITUs with doors, headwalls and sideboards

Closing Systems

All latches have to be closed and blocked.



Door and sideboard hinges

They have to be free from defects.



8.9 Regulations for ITUs with openable roofs

Roof fastening systems

Roofs have to be closed and secured to guarantee that they do not open spontaneously during the journey.



8.10 Specific regulations for swap bodies / containers

Lower corner anchors

The 4 lower corner anchors needed to fix the ITU have to be complete, non-deformed and with no cracks in the fixing welds.



8.11 Specific regulations for swap bodies

Safety equipment for support legs

If a safety device is damaged, the support legs are secured with a suitable fastening system to prevent them from coming out during the trip.



Support leg safely stowed.



8.12 Specific regulations for containers

Upper corner pieces

The 4 corner pieces which serve to couple the ITU with the spreader of the crane must be complete and comply with the regulations in force, not be deformed and have no cracks in the fixing welds.



8.13 Regulations for empty stacked flats

- The empty stacked flat containers can be transported only on wagons suitable for combined transport and respecting the loading profile limit. This exclusively if they are of the same type, same length and if they are joined together by means of four intermediate supports, each one with a twist lock of the same type, or if they are screwed together.
- In the automatic or semi-automatic closure systems, the condition of the blocking devices has to be visually recognizable.
- In the manual closure systems, the lever of the twist lock in the closed position has to be fixed, in order to exclude any unlocking due to involuntary movement or to incorrect closure.



- Should the junction elements be used without the twist lock, the stacked flat containers have to be secured together with at least 2 fastenings (min. tensile strength in straight traction: 1400 daN) and equipped with protections on the sharp edges. Fastening belts or bands are only to be used.

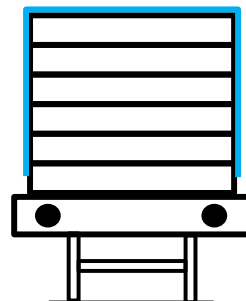

On sharp edges, belts have to be protected **by means of** edge covers.



- In case of stacked flats, the upturned front walls of the upper containers have to be fastened with bindings against involuntary lifting (tensile strength in a straight traction, at least 1400 daN).

Lift lever in the locked position



Frontal wall upturned and secured with a ligature

8.14 Regulations for flats with frontal doors

The raised extremity walls in the flats with or without tarpaulin have always to be secured with twist locks. Furthermore, the movable elements of the frontal and lateral walls have to be secured against accidental movements.

8.15 Specific regulations for semi-trailers

King pin of the fifth wheel

The king pin of the fifth wheel has to be in good condition and correctly fixed to the semi-trailer plate.

The semi-trailer, once loaded onto the pocket wagon, must have the king pin correctly inserted in the funnel of the jack.

WRONG position of the king pin, serious danger for the railway activity!!

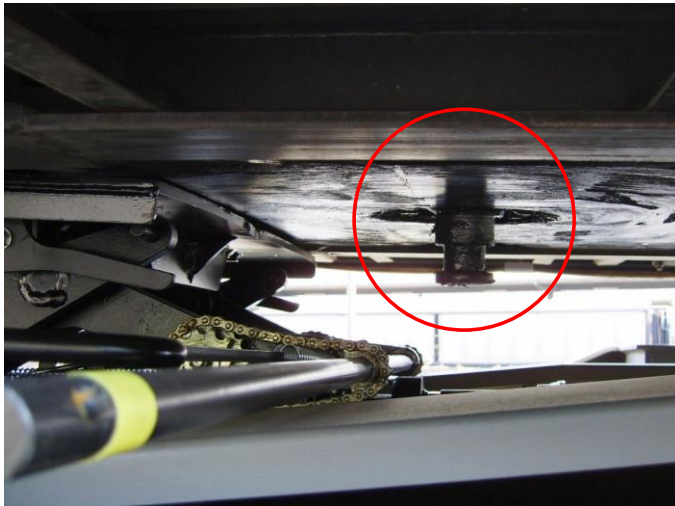

MANDATORY CHECK OF
THE CORRECT
CLOSURE / COUPLING

As the semi-trailer is not secured with the king pin, it is free to move in both longitudinal and transverse direction, thus surpassing the profile with the risk of hitting fixed parts of the railway infrastructure and passing trains.

In this case the semi-trailer, the vehicles on the trains and the railway infrastructure might be damaged and cause a serious accident along the rail route!!

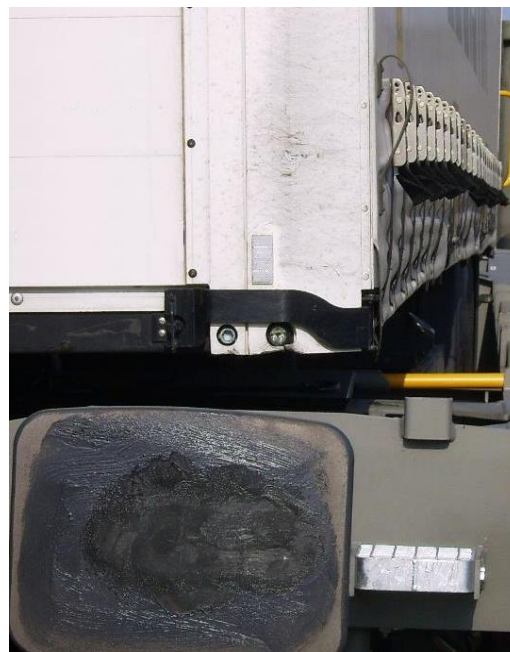

Rear bumper bars

The folding rear bumpers of semi-trailers shall not be deformed so that they cannot be tipped over and have to be securely attached.



Support legs

Support legs have to be completely raised resp. folded before their transshipment onto the railway wagon.



Failure to ensure the above could cause serious danger and damage both the semi-trailer and the railway infrastructure.



Air suspensions

Semi-trailers equipped with air suspensions are labeled with the following pictogram:

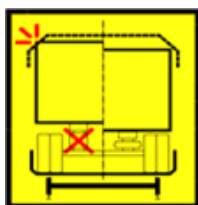

Before loading these semi-trailers onto wagons, the brakes shall be loosened and the air completely discharged from the suspensions. The transshipment and the shipment have always to be carried out with emptied and completely lowered air suspensions.

The semi-trailer can be transported with the brake on or off.

8.16 Regulations for swap bodies and semi-trailers

Crane grips

Crane grips and protections for sideboards / tarpaulins have to be constructed in accordance with the UIC/IRS regulations and be in a faultless condition.

In addition, protections shall consist of a single piece.

Protections have to be secured so that the supporting surface is smooth (with no projecting part) where the grips take hold.

There shall be an about 10cm-high yellow marking above the crane grips.



SAFETY FIRST!

Have a good trip!!